

HI98193

Dissolved Oxygen BOD/OUR/SOUR Meter



INSTRUCTION MANUAL

Dear Customer,

Thank you for choosing a Hanna Instruments product.

Please read this instruction manual carefully before using the instrument.

This manual will provide you with the necessary information for correct use of the instrument, as well as a precise idea of its versatility.

If you need additional technical information, do not hesitate to e-mail us at tech@hannainst.com or view our worldwide contact list at www.hannainst.com.

All rights are reserved. Reproduction in whole or in part is prohibited without the written consent of the copyright owner, Hanna Instruments Inc., Woonsocket, Rhode Island, 02895, USA.

PRELIMINARY EXAMINATION	4
GENERAL DESCRIPTION	5
FUNCTIONAL DESCRIPTION	6
SPECIFICATIONS	8
PROBE FUNCTIONAL DESCRIPTION	9
PROBE CONNECTION AND PREPARATION	10
OPERATIONAL GUIDE	11
OUR MEASUREMENT	20
SOUR MEASUREMENT	22
TEMPERATURE MEASUREMENT	25
DO CALIBRATION PROCEDURE	25
GOOD LABORATORY PRACTICE (GLP)	29
SETUP	30
LOGGING	42
AutoEnd	46
PRESSURE CALIBRATION	47
TEMPERATURE CALIBRATION (for technical personnel only)	49
PC INTERFACE	52
BATTERIES REPLACEMENT	59
PROBE MAINTENANCE	60
TROUBLESHOOTING GUIDE	61
ACCESSORIES	62

Remove the instrument from the packing material and examine it carefully to make sure that no damage has occurred during shipping. If there is any damage, please contact your local Hanna Instruments Office.

Each instrument is supplied with:

- [HI764073](#) Polarographic probe with built-in temperature sensor and 4 m (13.1') cable
- [HI76407A](#) Membrane cap (2 pcs.)
- [HI7040](#) Bicomponent Zero Oxygen Solution
- [HI7041S](#) Electrolyte solution (30 mL)
- [HI920015](#) Micro USB cable
- DO protective cap
- O-Rings (2 pcs.)
- 100 mL Plastic Beaker (2 pcs.)
- 1.5V AA Batteries (4 pcs.)
- Instruction manual and Quick Reference Guide
- Certificate

Note: Save all packing material until you are sure that the instrument functions correctly. All defective items must be returned in the original packing with the supplied accessories.

The HI98193 is a state of art, microprocessor based, dissolved oxygen instrument with many automated and specific application features, designed to provide laboratory results and accuracy under harsh industrial conditions.

All measurements are automatically compensated for temperature. Manual salinity compensation in water allows direct determination of dissolved oxygen in saline waters. With its internal barometer, the instrument is able to automatically compensate for changes in barometric pressure so there is no need for charts, altitude information or external barometric pressure information.

The instrument contains built-in application software for the calculation of Biochemical Oxygen Demand (BOD), Oxygen Uptake Rate (OUR) and Specific Oxygen Uptake Rate (SOUR).

HI98193's calibration has been greatly simplified when compared to other dissolved oxygen instruments. It is provided with a series of new features which add entirely new dimensions to the measurement of DO, by allowing the user to dramatically improve the reliability of the measurement:

- One or two points automatic dissolved oxygen calibration.
- One point manual dissolved oxygen calibration using a value in milligrams per liter or percent saturation entered by the user.
- One or two points user temperature calibration.
- Messages on the graphic LCD for an easy and accurate calibration.
- User-selectable "calibration time out" to remind when a new calibration is necessary.

Moreover, the meter offers an extended temperature range from -20.0 °C to 120.0 °C (-4.0 °F to 248.0 °F).

Other features include:

- Log on demand up to 400 samples.
- Auto Hold feature, to freeze first stable reading on the LCD.
- GLP feature, to view last calibration data.
- PC interface.

FRONT VIEW

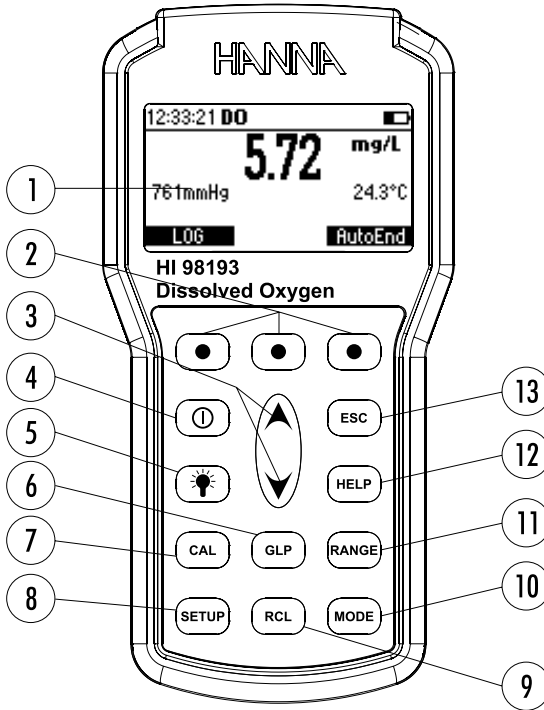

- 1) Liquid Crystal Display (LCD).
- 2) F1, F2, F3 functional keys.
- 3) ▲ / ▼ keys to manually increase/decrease the parameters or to scroll through the menu.
- 4) ON/OFF (⏻) key, to turn the instrument ON and OFF.
- 5) LIGHT (💡) key, to toggle display backlighting.
- 6) GLP key, to display Good Laboratory Practice information.
- 7) CAL key, to enter/exit calibration mode.
- 8) SETUP key, to enter/exit SETUP mode.
- 9) RCL key, to enter/exit view logged data mode (RCL means RECALL).
- 10) MODE key to change DO measuring unit when in DO measurement mode, or to toggle between standard and pressure in DO calibration.
- 11) RANGE key, to switch between DO, BOD, OUR AND SOUR.
- 12) HELP key to enter/exit contextual help.
- 13) ESC key to leave current mode, exit calibration, setup, help, etc.

TOP VIEW

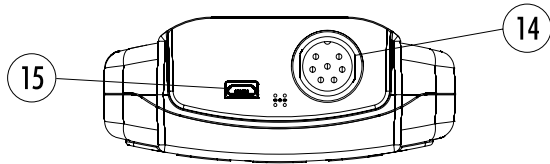

- 14) Electrode **DIN** connector.
- 15) USB connector.

Dissolved Oxygen	Range	0.00 to 50.00 mg/L / 0.0 to 600.0 % saturation
	Resolution	0.01 mg/L / 0.1 % saturation
	Accuracy	±1.5 % of reading ±1 digit
Barometric Pressure	Range	450 to 850 mmHg
	Resolution	1 mmHg
	Accuracy	±3 mmHg within ±15 % from the calibration point
Temperature	Range	-20.0 to 120.0 °C (-4.0 to 248.0 °F)
	Resolution	0.1 °C (0.1 °F)
	Accuracy	±0.2 °C (±0.4 °F) (excluding probe error)
DO Calibration	<ul style="list-style-type: none"> • One or two points automatic calibration at 100 % (8.26 mg/L) and 0 % (0 mg/L). • One point manual using a value entered by the user in % saturation or mg/L. 	
Temperature Calibration	One or two point at any in range temperature value	
Pressure Calibration	One point at any in range pressure value	
Temperature Compensation	Automatic from 0.0 to 50.0 °C (32.0 to 122.0 °F)	
Pressure Compensation	Automatic from 450 to 850 mmHg	
Salinity Compensation	Automatic from 0 to 70 g/L	
DO Probe	HI764073 Polarographic Probe	
LOG	On demand, 400 samples	
Battery Type / Life	1.5V AA batteries (4 pcs.) / approx. 200 hours of continuous use without backlight (50 hours with backlight)	
Auto Power Off	User selectable: 5, 10, 30, 60 minutes or disabled	
PC Connectivity	Opto-isolated USB	
Dimensions	185 x 93 x 35.2 mm (7.3 x 3.6 x 1.4")	
Weight	400 g (14.2 oz)	
Environment	0 to 50 °C (32 to 122 °F) max. RH 100% IP67	

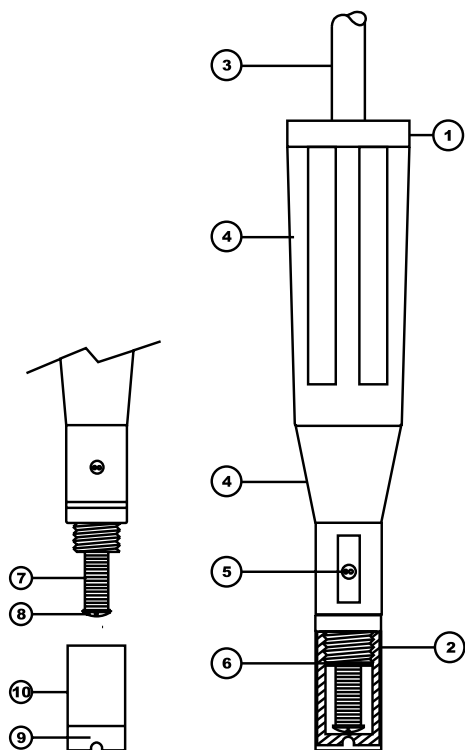

1. DO Probe
2. Protective Cap
3. Watertight Shielded Cable
4. Polypropylene Probe Body
5. Temperature Sensor
6. O-Ring Seal
7. Silver Chloride Anode
8. Platinum Cathode (sensor)
9. Oxygen Permeable PTFE® Membrane
10. Membrane Cap

To take measurements, connect the DO probe to the meter securely by aligning the pins with the socket located on the top of the meter, pushing the plug in and tightening the threaded ring.

Probes shipped from Hanna Instruments are dry. To hydrate the probe and prepare it for use, connect it to the meter and proceed as follows:

1. Remove the red and black plastic cap. This cap is for shipping purposes and can be thrown away.
2. Wet the sensor by soaking the bottom 2½ cm (1") of the probe in electrolyte (HI7041S) for 5 minutes.
3. Rinse the membrane cap (HI76407A) supplied in the kit with the meter with electrolyte solution while shaking it gently. Refill with clean electrolyte solution.
4. Tap gently the sides of the membrane cap with your finger tip to ensure that no air bubbles are trapped. To avoid damaging the membrane, do not tap it directly on the bottom.
5. Make sure that the rubber O-Ring sits properly inside the membrane cap.
6. With the sensor facing down, slowly screw the cap clockwise. Some electrolyte will overflow.

When not in use and during polarization (see PROBE CONDITIONING page 11), use the protective transparent cap supplied in the kit with the meter.

Shipping cap

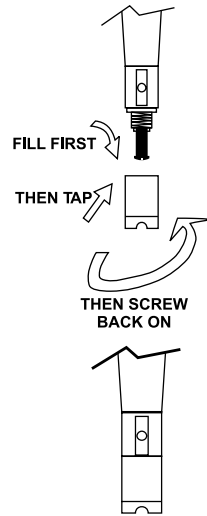
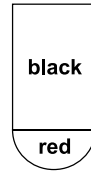

INITIAL PREPARATION

The instrument is supplied complete with batteries. See Batteries Replacement for details, page 59. To prepare the instrument for field measurements close the USB communication socket and all unused connector sockets with proper stopper (to ensure waterproof protection).

Connect the DO probe to the 7-pin connector. Make sure that the probe sleeve is properly inserted and tighten the threaded ring.

Turn the instrument **ON** by pressing **ON/OFF** key.

At start-up the display will show the Hanna Instruments logo for a few seconds, followed by the percentage indication of the remaining battery life, then enters the probe conditioning mode. The probe will be conditioned for one minute, and afterwards the instrument will enter measurement mode. If the DO probe is not connected or is damaged, the conditioning period is skipped.

To save battery life, the Auto Power Off feature turns the instrument off after a set period (default 30 min) if no button is pressed. To set another period or to disable this feature, see **SETUP** menu on page 30.

The Auto Light Off backlight feature turns the backlight off after a set period (default 1 min) with no buttons pressed. To set another period or to disable this feature, see **SETUP** on page 30.

PROBE CONDITIONING

Probe polarization is essential for stable, accurate measurements. Probe polarization ensures the electrodes are conditioned and any oxygen dissolved in the electrolyte is consumed, so the only oxygen present will be oxygen diffusing from sample across the PTFE membrane. It is recommended to wait for at least 15 minutes to ensure precise conditioning of the probe.

When the probe is properly polarized, dissolved oxygen is consumed as it passes through the PTFE membrane into the electrolyte at the platinum cathode, and an accurate DO reading is displayed.

When the probe is not polarized, oxygen from the test solution as well as oxygen present in the electrolyte solution are detected, resulting in an incorrect DO reading.

SALINITY COMPENSATION

If the sample contains significant concentration of salinity, the read out values must be corrected, taking into account the lower degree of oxygen solubility in this situation. Before taking any DO measurements remember to set the salinity value from the SETUP menu (page 30).

The salinity affects the DO concentration, decreasing its value. The table below shows the maximum oxygen solubility at various temperatures and salinity levels.

°C	Salinity (g/l) at Sea Level					°F
	0 g/l	10 g/l	20 g/l	30 g/l	35 g/l	
0	14.60	13.64	12.74	11.90	11.50	32.0
2	13.81	12.91	12.07	11.29	10.91	36.5
4	13.09	12.25	11.47	10.73	10.38	39.2
6	12.44	11.65	10.91	10.22	9.89	42.8
8	11.83	11.09	10.40	9.75	9.44	46.4
10	11.28	10.58	9.93	9.32	9.03	50.0
12	10.77	10.11	9.50	8.92	8.65	53.6
14	10.29	9.68	9.10	8.55	8.30	57.2
16	9.86	9.28	8.73	8.21	7.97	60.8
18	9.45	8.90	8.39	7.90	7.66	64.4
20	9.08	8.56	8.07	7.60	7.38	68.0
22	8.73	8.23	7.77	7.33	7.12	71.6
24	8.40	7.93	7.49	7.07	6.87	75.2
25	8.24	7.79	7.36	6.95	6.75	77.0
26	8.09	7.65	7.23	6.83	6.64	78.8
28	7.81	7.38	6.98	6.61	6.42	82.4
30	7.54	7.14	6.75	6.39	6.22	86.0
32	7.29	6.90	6.54	6.19	6.03	89.6
34	7.05	6.68	6.33	6.01	5.85	93.2
36	6.82	6.47	6.14	5.83	5.68	96.8
38	6.61	6.28	5.96	5.66	5.51	100.4
40	6.41	6.09	5.79	5.50	5.36	104.0
42	6.22	5.93	5.63	5.35	5.22	107.6
44	6.04	5.77	5.48	5.21	5.09	111.2
46	5.87	5.61	5.33	5.07	4.97	114.8
48	5.70	5.47	5.20	4.95	4.85	118.4
50	5.54	5.33	5.07	4.83	4.75	122.0

Note: The relationship between salinity and chlorinity for seawater is given by the equation below: $Salinity (g/l) = 1.80655 \text{ Chlorinity } (g/l)$

BAROMETRIC PRESSURE COMPENSATION

The dissolved oxygen saturation value varies with pressure, so it is important to compensate the effect that pressure has on DO measurements.

°C	Altitude, Meters above Sea Level															°F
	0 m	300 m	600 m	900 m	1200 m	1500 m	1800 m	2100 m	2400 m	2700 m	3000 m	3300 m	3600 m	3900 m	4000 m	
0	14.6	14.1	13.6	13.1	12.6	12.1	11.7	11.2	10.8	10.4	10.0	9.7	9.3	9.0	8.9	32.0
2	13.8	13.3	12.8	12.4	11.9	11.5	11.0	10.6	10.2	9.9	9.5	9.2	8.8	8.5	8.4	35.6
4	13.1	12.6	12.2	11.7	11.3	10.9	10.5	10.1	9.7	9.3	9.0	8.7	8.4	8.0	7.9	39.2
6	12.4	12.0	11.5	11.1	10.7	10.3	9.9	9.6	9.2	8.9	8.6	8.2	7.9	7.6	7.5	42.8
8	11.8	11.4	11.0	10.6	10.2	9.8	9.5	9.1	8.8	8.4	8.1	7.8	7.5	7.3	7.2	46.4
10	11.3	10.9	10.5	10.1	9.7	9.4	9.0	8.7	8.4	8.1	7.8	7.5	7.2	6.9	6.8	50.0
12	10.8	10.4	10.0	9.6	9.3	8.9	8.6	8.3	8.0	7.7	7.4	7.1	6.9	6.6	6.5	53.6
14	10.3	9.9	9.6	9.2	8.9	8.5	8.2	7.9	7.6	7.4	7.1	6.8	6.6	6.3	6.2	57.2
16	9.9	9.5	9.2	8.8	8.5	8.2	7.9	7.6	7.3	7.0	6.8	6.5	6.3	6.1	6.0	60.8
18	9.5	9.1	8.8	8.5	8.1	7.8	7.6	7.3	7.0	6.8	6.5	6.3	6.0	5.8	5.7	64.4
20	9.1	8.8	8.4	8.1	7.8	7.5	7.3	7.0	6.7	6.5	6.2	6.0	5.8	5.6	5.5	68.0
22	8.7	8.4	8.1	7.8	7.5	7.2	7.0	6.7	6.5	6.2	6.0	5.8	5.6	5.4	5.3	71.6
24	8.4	8.1	7.8	7.5	7.2	7.0	6.7	6.5	6.2	6.0	5.8	5.6	5.4	5.2	5.1	75.2
25	8.3	8.0	7.7	7.4	7.1	6.8	6.6	6.4	6.1	5.9	5.7	5.5	5.3	5.1	5.0	77.0
26	8.1	7.8	7.5	7.2	7.0	6.7	6.5	6.2	6.0	5.8	5.6	5.4	5.2	5.0	4.9	78.8
28	7.8	7.5	7.3	7.0	6.7	6.5	6.2	6.0	5.8	5.6	5.4	5.2	5.0	4.8	4.7	82.4
30	7.6	7.3	7.0	6.8	6.5	6.3	6.0	5.8	5.6	5.4	5.2	5.0	4.8	4.6	4.6	86.0
32	7.3	7.0	6.8	6.5	6.3	6.1	5.8	5.6	5.4	5.2	5.0	4.8	4.7	4.5	4.4	89.6
34	7.1	6.8	6.6	6.3	6.1	5.9	5.6	5.4	5.2	5.0	4.9	4.7	4.5	4.3	4.3	93.2
36	6.8	6.6	6.3	6.1	5.9	5.7	5.5	5.3	5.1	4.9	4.7	4.5	4.4	4.2	4.1	96.8
38	6.6	6.4	6.1	5.9	5.7	5.5	5.3	5.1	4.9	4.7	4.5	4.4	4.2	4.1	4.0	100.4
40	6.4	6.2	5.9	5.7	5.5	5.3	5.1	4.9	4.7	4.6	4.4	4.2	4.1	3.9	3.9	104.0
42	6.2	6.0	5.8	5.6	5.3	5.2	5.0	4.8	4.6	4.4	4.3	4.1	4.0	3.8	3.8	107.6
44	6.0	5.8	5.6	5.4	5.2	5.0	4.8	4.6	4.5	4.3	4.1	4.0	3.8	3.7	3.7	111.2
46	5.8	5.6	5.4	5.2	5.0	4.8	4.7	4.5	4.3	4.2	4.0	3.9	3.7	3.6	3.5	114.8
48	5.7	5.5	5.3	5.1	4.9	4.7	4.5	4.4	4.2	4.0	3.9	3.7	3.6	3.5	3.4	118.4
50	5.5	5.3	5.1	4.9	4.7	4.6	4.4	4.2	4.1	3.9	3.8	3.6	3.5	3.4	3.3	122.0

The **HI98193** meter contains a built-in barometer, and it is able to automatically compensate for changes in barometric pressure. If another pressure value than the barometer's reading is to be used, then the manual pressure feature must be enabled from the **SETUP** menu (see page 30), and afterwards the pressure value can be set using the **▲/▼** keys.

The table below contains a conversion altitude (m) to pressure (mmHg) for the altitude values from the previous table.

Altitude (m)	0	300	600	900	1200	1500	1800	2100	2400	2700	3000	3300	3600	3900	4000
Pressure (mmHg)	760	732	705	679	654	630	607	584	563	542	522	503	484	467	461

DO MEASUREMENTS

Make sure the probe's protective cap has been removed.

In order to take accurate dissolved oxygen measurements make sure that the instrument has been calibrated (see page 25 for details).

Press **RANGE** to access the DO measure screen. If necessary press **MODE** to change the measuring unit. Immerse the tip of the probe into the sample to be tested. Allow approximately one minute for the reading to stabilize (hourglass symbol turns off).

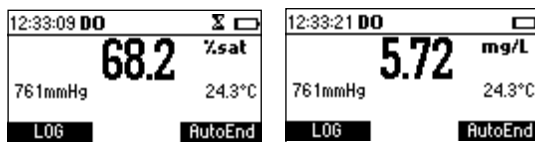

On the screen are displayed:

- Dissolved Oxygen reading in the selected unit (% saturation or mg/L)
- Temperature reading in the selected unit (°C or °F)
- Pressure reading in the selected unit (mmHg, inHg, atm, psi, kPa, mbar). If the Manual Pressure option is enabled (♦ displayed in front of the pressure value) the pressure value can be changed using the **▲/▼** keys.

For accurate dissolved oxygen measurements, a water movement of 0.3 m/s is required. This is to ensure that the oxygen-depleted membrane surface is constantly replenished. A moving stream will provide adequate circulation.

BOD MEASUREMENTS

Biochemical oxygen demand (BOD) is an indicator for the concentration of biodegradable organic matter present in a sample of water. It can be used to infer the general quality of the water and its degree of pollution. BOD measures the rate of oxygen uptake by microorganisms in a sample of water at a fixed temperature and over a given period of time. To ensure that all other conditions are equal, a very small amount of microorganism seed is added to each sample being tested. This seed is typically generated by diluting activated sludge with deionized water. The samples are kept at 20 °C in the dark and tested for dissolved oxygen (DO) after five days. The loss of dissolved oxygen in the sample, once corrections have been made for the degree of dilution, is called the BOD₅.

Before measuring BOD, remember to set the BOD configuration from the SETUP menu (see page 30). Press **RANGE** to access the BOD measurement screen.

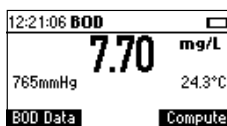

Press **BOD Data** to view the BOD initial data management screen.

Press **Compute** to evaluate the BOD for a specified sample (available only when the measurement is stable and at least one initial BOD data record has been memorized).

BOD initial data management screen

BOD Data is pressed while in BOD measurement screen.

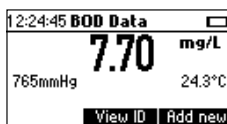

Press **Add new** to add a new BOD initial data record (the key is available only when the measurement is stable). A 200 records memory space is available for BOD initial data.

Press **View ID** to view the saved BOD initial values (the key is available only when at least one initial BOD data record has been memorized).

By pressing **Add New** the BOD Parameters screen will be displayed:

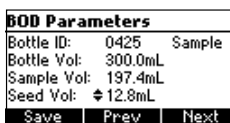

BOD Parameters:

- **Bottle ID:** a number used to identify a specific bottle.
Range: 0000 to 9999.
- **The type of the Sample:** Sample or Seed.
- **Bottle Volume:** the total volume of the BOD bottle.
Range: 0.1 to 300.0 mL.
- **Sample Volume:** the volume of sample in the BOD bottle.
Range: 0.1 to 300.0 mL (for a seed sample this value is 0.0 mL and cannot be set).
- **Seed Volume:** the volume of seed in the BOD bottle.
Range: 0.0 to 300.0 mL.

Press **Prev/Next** to select a different parameter on the screen.

Press **▲/▼** keys to modify the selected parameter's value.

Press **Save** to save the BOD parameters and the initial DO, temperature, pressure and salinity values for the specified bottle.



If a bottle with the same ID already exists, the instrument will ask for replacement confirmation.

Press **Replace** to replace the existing record, or **ESC** to return to the previous screen without replacing.

When a new record is saved the meter will display a message indicating the remaining free BOD initial data space in %.

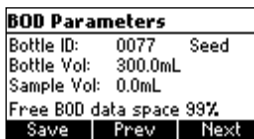

By pressing **View ID** a list of all the saved BOD initial data records will be displayed. The seed records will have the symbol "*" displayed after the bottle ID.

ID	DO(mg/L)	Date
0000	7.89	2006/01/06
0001	7.70	2006/01/06
0003*	7.73	2006/01/06
0004	7.76	2006/01/06

At the bottom of the table are three buttons: "Delete All", "Delete", and "More".

Use the ▲/▼ keys to scroll the list of BOD initial data records.

Press **More** to view detailed information for the selected record.

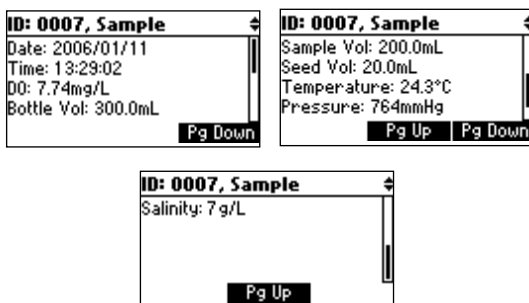

Press **Pg Up/Pg Down** to view the next/previous screen of information.

Use the ▲/▼ keys to view the detailed information about the next/previous record.

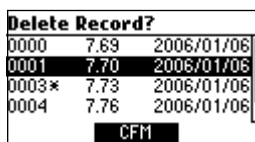

If **Delete** is pressed, use the ▲/▼ keys to highlight the record to be deleted and then press **CFM**.

Press **ESC** to exit.

If **Delete All** is pressed the instrument asks for confirmation. Press **CFM** to confirm or **ESC** to exit without deleting.

BOD evaluation

From the **BOD** measure screen press **Compute** to evaluate the BOD for a specified sample. The following screen will be displayed.

If the date of the current measurement is previous to the date of the selected measurement then the **Eval. BOD** key will not be displayed.

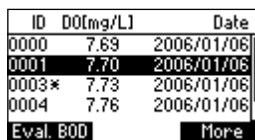

Press **MORE** to view detailed information for the selected record.

Use ▲/▼ keys to select the bottle for BOD evaluation.

Press **Eval. BOD** to compute the BOD for the selected bottle. If the time difference between the current reading and the selected reading is less than 1 day the instrument will ask for record replacement confirmation, and the BOD can't be evaluated.

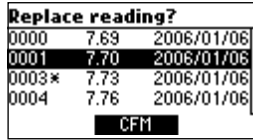

Press **CFM** to replace the selected records DO, temperature, pressure and salinity values with the current values.

Press **ESC** to return to the previous screen without replacing.

If the conditions regarding the time difference are met, after pressing the **Eval. BOD** key, the instrument will display the computed BOD value.

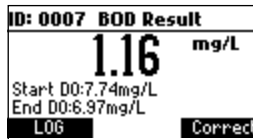

Press **LOG** to save the BOD result.

Press **ESC** to return to the BOD measure screen.

If the final DO reading or DO loss doesn't meet the criteria for BOD measurements set from the instrument's setup, a warning message will be displayed.

Press any key to clear the warning message from the display or press **HELP** to view detailed information about the warning.

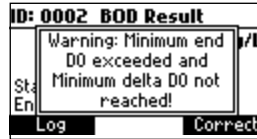

Note: If the Autodelete BOD start data option is enabled in SETUP (see page 30), when the BOD result is saved (LOG key is pressed) the corresponding BOD initial data record will be automatically deleted from the instrument's memory.

Seed Correction

In case that the BOD was evaluated for a seeded sample and the list of the saved seed BOD values is not empty, the **Correct** functional key will be displayed.

Press **Correct** to view the list of the saved seed BOD values.

ID	BOD(mg/L)	Date
0031	6.60	2006/01/11
0032	3.00	2006/01/11
0033	36.60	2006/01/11
0063	36.60	2006/01/11

Correct More

Select the desired seed BOD and then press **Correct** to compute the corrected BOD value. The instrument will display the corrected BOD value.

If the information about the BOD of a certain seed doesn't exist at the moment of the BOD evaluation for a seeded sample, the sample's BOD can be corrected at a later time from the **BOD recall** menu (view logged BOD data).

In order to perform a seed correction from the **BOD recall**, press **RCL** key from the BOD measurement screen to enter **BOD recall**, select the desired BOD record and press **More**. The instrument will display a complete set of information about the selected record.

Press **Correct** to view the list of the seed values.

Select the desired seed BOD and then press **Correct** to compute the corrected BOD value. The new BOD value will be displayed.

Note: If the final DO value is greater than the initial DO value an error message will be displayed.



The OUR is used to determine the oxygen consumption or respiration rate in water. It is defined as the mg/L of oxygen consumed per hour.

The following equation is used for OUR determination:
where:

$$\text{OUR} = \left(\frac{\text{DO}_{\text{START}} - \text{DO}_{\text{END}}}{t_{\text{ELAPSED}}} \right) \times \left(\frac{3600 \text{ sec}}{1 \text{ h}} \right) \times \left(\frac{\text{total volume}}{\text{sample volume}} \right)$$

DO_{START} = Dissolved oxygen level at start of test

DO_{END} = Dissolved oxygen level at end of test

t_{ELAPSED} = Elapsed time of test in seconds

total volume/sample volume = Dilution factor of sample

Before starting an OUR test remember to set the OUR configuration from the **SETUP** menu (page 30).

OUR measurement screen:

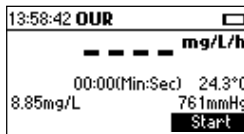

Press **Start** to begin a new OUR test.

If the DO value is less than the minimum start DO value the meter will display an error message, and the test cannot be started.

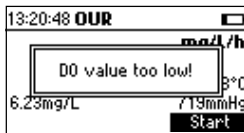

If the minimum start DO condition is met the instrument will display the instantaneous oxygen consumption rate and the amount of time that has passed from the beginning of the test.

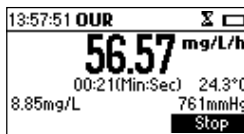

If the DO reading is less than the minimum end DO value set during OUR configuration a warning icon will be displayed and a beep will be heard every two seconds. Press **Stop** to stop the test and the beeper.



To end the OUR test before the maximum time interval set during OUR configuration press **Stop**. If **Stop** is pressed before the minimum time for the OUR test has elapsed, the instrument will display a warning message.



Press **Resume** to continue the test or **Stop** to end the test. At the end of the test the meter will display the computed OUR value and the duration of the test. Press **LOG** to save a complete set of data regarding the OUR test. Press **Start** to begin a new OUR test.



Notes: If at the end of the test the DO reading is less than the minimum end DO value set during OUR configuration, a warning message will be displayed.

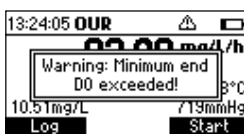

*Press any key to clear the message from the screen, or press **HELP** to view detailed information about the warning.*

If the DO value at the end of the test is greater than the DO value from the beginning of the test an error message will be displayed.

*Press **Start** to begin a new OUR test or **ESC** to return to the OUR measure screen.*

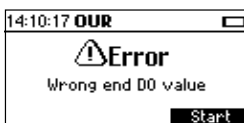

The Specific Oxygen Uptake Rate (SOUR), also known as the oxygen consumption or respiration rate, is defined as the milligram of oxygen consumed per gram of volatile suspended solids (VSS) per hour. This quick test has many advantages: rapid measure of influent organic load and biodegradability, indication of the presence of toxic or inhibitory wastes, degree of stability and condition of a sample, and calculation of oxygen demand rates at various points in the aeration basin.

The following equation is used for SOUR determination:

$$\text{SOUR} = \text{OUR} / \text{Solids Weight}$$

where:

OUR is the Oxygen Uptake Rate (see equation on page 20)

Solids Weight is the **Total solids** or the **Volatile suspended solids** weight in g/L

Temperature correction:

The SOUR value is corrected to 20 °C (68 °F) according to the Farrel and Bhide equation:

$$\text{SOUR}_{20} = \text{SOUR}_T \Theta^{(20-T)}$$

Where T is the measured temperature in °C and Θ is a temperature dependent variable:

$$\Theta = 1.05 \text{ for } T \text{ above } 20\text{ }^\circ\text{C}$$

$$\Theta = 1.07 \text{ for } T \text{ below } 20\text{ }^\circ\text{C}$$

This calculation is valid only for temperature values in the range 10 to 30 °C. Temperature correction is performed only if the option **SOUR @ 20 °C** is enabled from **SOUR configuration** in the setup menu.

Before starting a SOUR test remember to set the SOUR configuration from the setup menu.

SOUR measurement screen:

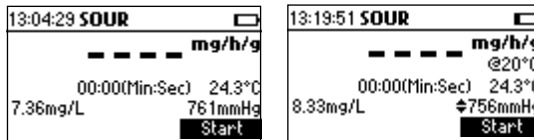

If the SOUR value is corrected to 20 °C (68 °F) the message “@20°C”, or “@68°F” according to the currently selected temperature unit, will be displayed above the measured temperature.

Press **Start** to begin a new SOUR test.

If the DO value is less than the minimum start DO value, the meter will display an error message, and the test cannot be started.

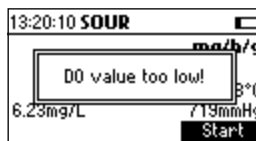

If the minimum start DO condition is met the instrument will display the instantaneous specific oxygen consumption rate and the amount of time that has passed from the beginning of the test.

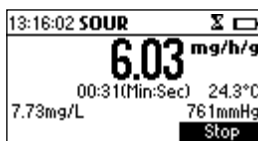

In case that the SOUR value is corrected to 20 °C (68 °F) and the measured temperature isn't in the range 10 to 30 °C the temperature value will blink to alert that the temperature correction isn't valid.



If the DO reading is less than the minimum end DO value set during SOUR configuration, a warning icon will be displayed and a beep will be heard every two seconds. Press **Stop** to stop the test and the beeper.

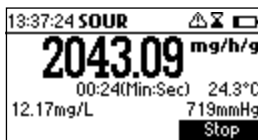

To end the SOUR test before the maximum interval set during SOUR configuration press **Stop**. If **Stop** is pressed before the minimum time for the SOUR test has elapsed the instrument will display a warning message.

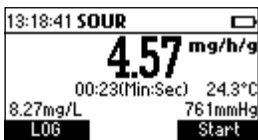

Press **LOG** to save a complete set of data regarding the SOUR test.



Press **Start** to begin a new SOUR test.

Notes: If the DO reading is less than the minimum end DO value set during SOUR configuration, a warning message will be displayed.

Press any key to clear the message from the screen, or press HELP to view detailed information about the warning.

If the DO value is greater than the DO value from the beginning of the test an error message will be displayed.



Press Start to begin a new SOUR test or ESC to return to the SOUR measure screen.

The DO probe has a built-in temperature sensor.

The measured temperature is indicated on the display.

Allow the probe to reach thermal equilibrium before taking any measurements. This can take several minutes. The greater the difference between the temperature at which the probe was stored and the temperature of the sample, the longer the time will be.

Note: If “—” is displayed instead of the measured temperature, the DO probe is not properly connected or the temperature is out of range. This also indicates the possibility of a broken probe cable.

The following options are available for the Dissolved Oxygen calibration:

- One point automatic zero calibration at 0% saturation or 0 mg/L
- One point automatic slope calibration at 100% saturation or 8.26 mg/L
- Two points automatic calibration at 0% saturation (0 mg/L) and 100% saturation (8.26 mg/L)
- One point manual calibration using a standard value set by the user in % saturation or mg/L

When automatic calibrations are performed it is assumed that the standard value is the saturated DO value at 25 °C, 0 g/L salinity and 760 mmHg.

When manual calibrations are performed it is assumed that the standard value is the DO value at the current pressure, temperature and salinity.

INITIAL PREPARATION

Make sure the probe is ready for measurements (see probe connection and preparation on page 10), i.e. the membrane is filled with electrolyte and the probe is connected to the meter.

For an accurate calibration, it is recommended to wait for at least 15 minutes to ensure precise conditioning of the probe.

Remove the protective cap from the DO probe.

Make sure the salinity value has been set to the salinity of the standard (see SETUP for details).

One point automatic zero calibration

Submerge the probe into [HI7040](#) zero oxygen solution and stir gently for 2-3 minutes.

Press **CAL**. The calibration menu will be displayed.

Press **DO** to select the DO calibration.



The DO calibration screen will be displayed and the standard 0% saturation (or 0 mg/L, depending on the currently selected measuring unit), will be automatically selected.

DO Calibration		Σ
0.6		%sat
767mmHg		24.3°C
Standard: ↕0.0%sat		
Manual		

The hourglass icon will be shown on the display until the reading becomes stable. When the reading is stable and within range of the selected standard, the **CFM** functional key is displayed.

DO Calibration		Σ
0.6		%sat
767mmHg		24.3°C
Standard: ↕0.0%sat		
Manual CFM		

Press **CFM** to confirm the calibration point.

Press **ESC** to leave calibration. The instrument will return to the main screen and will memorize the zero calibration data.

One point automatic slope calibration

It is suggested to perform the slope calibration in air. Allow the probe tip to dry.

Press **CAL**. The calibration menu will be displayed. Press **DO** to select the DO calibration. The 100% saturation standard (or the 8.26 mg/L standard, according to the currently selected measuring unit), will be automatically selected.

DO Calibration		Σ
94.6		%sat
767mmHg		24.3°C
Standard: ↕100.0%sat		
Manual		

The hourglass icon will be shown on the display until the reading becomes stable. When the reading is stable and within range of the selected buffer, the **CFM** functional key is displayed.

DO Calibration		Σ
94.6		%sat
767mmHg		24.3°C
Standard: ↕100.0%sat		
Manual CFM		

Press **CFM** to confirm the calibration point.

The instrument will return to the main screen and will memorize the slope calibration data.

Two points automatic calibration

Submerge the probe into **HI7040** zero oxygen solution and stir gently for 2-3 minutes.

Press **CAL**. The calibration menu will be displayed.

Press **DO** to select the DO calibration. The DO calibration screen will be displayed and the standard 0% saturation (0 mg/L) will be automatically selected.

The hourglass icon will be shown on the display until the reading becomes stable.

When the reading is stable and within range of the selected standard, the **CFM** functional key is displayed.

Press **CFM** to confirm the calibration point.

The meter will automatically select the 100% saturation (8.26 mg/L) standard.

Gently shake the probe dry. Leave the probe in air.

The hourglass icon will be shown on the display until the reading becomes stable.

When the reading becomes stable within an acceptable range of the selected standard, the **CFM** functional key is displayed.

Press **CFM** to confirm the calibration point. The instrument will return to the main screen and will memorize the calibration data.

One point manual calibration

First determine the dissolved oxygen value of the sample (use a Winkler titration). Place the probe in the sample and provide adequate stirring.

Access the DO calibration screen as described in the previous DO calibration procedures.

Press the **Manual** functional key.

The standard value can be changed using the **▲/▼** keys in the range 0 to 100% saturation or 0.00 to 8.26 mg/L, depending on the currently selected measuring unit.

DO Calibration		Σ
94.7		%sat
766mmHg		24.3°C
Standard: 98.4% sat		
Auto		

Set the standard value using the **▲/▼** keys to the determined DO value.

The hourglass icon will be shown on the display until the reading becomes stable.

When the reading is stable and within range of the selected standard, the **CFM** functional key is displayed

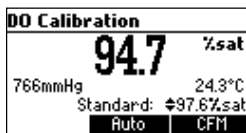

Press **CFM** to confirm the calibration point.

The instrument will return to the main screen and will memorize the calibration data.

Notes: If the manual pressure feature is enabled, during the DO calibration it is possible to switch between changing the standard value or the pressure value by pressing the Pressure/Standard functional key or the MODE key.



If a previous calibration has been performed it is possible to erase the calibration by pressing the Clear functional key while in the DO calibration screen.



The "Calibration cleared" message will be displayed for a few seconds and the meter will return to the main screen. If the manual pressure feature is enabled, the Clear key will be active only for 5 seconds after accessing the DO calibration screen, and afterwards it will be replaced by the Pressure/Standard functional key.

If the DO value measured by the instrument is not within range of the selected standard, the "Wrong standard" error message will be shown on the display and the calibration can't be confirmed.



While in manual calibration mode it is possible to return to the automatic calibration mode by pressing the AUTO functional key. The meter will select the standard that is closest to the current DO reading.

GLP is a set of functions that allows storage and retrieval of data regarding the maintenance and status of the electrode.

All data regarding DO calibration is stored for the user to review when necessary.

EXPIRED CALIBRATION

The calibration time out can be set (see SETUP for details, page 30) from 1 to 7 days or can be disabled. The instrument is provided with a real time clock (RTC) in order to monitor the time elapsed since the last DO calibration.

The real time clock is reset every time the instrument is calibrated and the “Expired Calibration” status is triggered when the instrument detects a calibration time out. The “CAL DUE” tags will start blinking to warn the user that the instrument should be recalibrated.

For example, if a 4 days time out has been selected, the instrument will issue the alarm exactly 4 days after the last calibration.

However, if at any moment the expiration value is changed (e.g. to 5 days), then the alarm will be immediately recalculated and appear 5 days after the last calibration.

Notes: When the instrument is not calibrated or the calibration is cleared (default values loaded) there is no “Expired Calibration”, and the display always shows the “CAL DUE” tags blinking. When an abnormal condition in the RTC is detected, the instrument forces the “Expired Calibration” status.

LAST DO CALIBRATION DATA

Data from the last DO calibration is stored automatically after a successful calibration. To view the last calibration data, press **GLP** when the instrument is in the DO, BOD, OUR or SOUR measurement mode.

Last DO cal	Standard
Date: 03-Feb-2006	0.00mg/L
Time: 11:39:38PM	8.26mg/L
Salinity: 1 g/L	
Pressure: 761mmHg	
Temperature: 24.3°C	
Cal Expire: Disabled	

The instrument will display GLP data related to calibration including calibration standard, salinity, pressure and temperature.

Note: “No user calibration” message is displayed if the calibration was cleared or the instrument hasn’t been calibrated for dissolved oxygen.

Setup mode allows viewing and modifying the measurement parameters.

The following table lists the **SETUP** parameters, their valid range and the factory default settings.

Item	Description	Valid value	Default
Calibr. Time-out	Number of days after calibr. warning is displayed	Disabled, 1 to 7 days	Disabled
Salinity	The solution's salt content	0 to 70 g/L	0 g/L
BOD Configuration			
Sample min delta DO	The minimum diff. between the start and the end DO val.	0.00 to 50.00 mg/L	0.00 mg/L
Sample min end DO	The minimum end DO value	0.00 to 50.00 mg/L	0.00 mg/L
Seed min delta DO	The minimum diff. between the start and the end DO val.	0.00 to 50.00 mg/L	0.00 mg/L
Seed min end DO	The minimum end DO value	0.00 to 50.00 mg/L	0.00 mg/L
OUR Configuration			
Min time	The minimum time for the OUR test	1 to 3600 sec.	1 sec.
Max time	The maximum time for the OUR test	1 to 3600 sec.	3600 sec.
Min start DO	The minimum DO value for starting the OUR test	0.01 to 50.00 mg/L	0.01 mg/L
Min end DO	The minimum DO value at the end of the OUR test	0.00 to 50.00 mg/L	0.00 mg/L
Total volume	The total volume of the solution to be tested	0.1 to 300.0 mL	0.1 mL
Sample volume	The volume of sample in the solution to be tested	0.1 to 300.0 mL	0.1 mL
SOUR configuration			
Min time	The minimum time for the SOUR test	1 to 3600 sec.	1 sec.
Max time	The maximum time for the SOUR test	1 to 3600 sec.	3600 sec.
Min start DO	The minimum DO value for starting the SOUR test	0.01 to 50.00 mg/L	0.01 mg/L
Min end DO	The minimum DO value at the end of the test	0.00 to 50.00 mg/L	0.00 mg/L

Total volume	The total volume of the solution to be tested	0.1 to 300.0 mL	0.1 mL
Sample volume	The volume of sample in the solution to be tested	0.1 to 300.0 mL	0.1 mL
Solids weight	Total solids or Volatile Suspended solids weight	0.1 to 300.0 g/L	0.1 g/L
SOUR @ 20 °C	Correct the SOUR value to 20 °C	Enabled or Disabled	Disabled
Autodelete BOD start data	Automatically delete BOD start data, after BOD compute	Enabled or Disabled	Disabled
Manual pressure	Set the pressure value using the ▲/▼ keys	Enabled or disabled	Disabled
Pressure unit		mmHg, inHg, atm, mbar, psi, kPa	mmHg
Temperature unit		°C or °F	°C
Backlight	Backlight Level	0 to 7	4
Contrast	Contrast Level	0 to 20	10
Auto light off	Time backlight remains ON	1, 5, 10, 30	1
Auto power off	Time until instrument is powered OFF	Disabled 5, 10, 30, 60	30
Date / Time		01.01.2006 to 12.31.2099 00 :00 to 23 :59	current date/time
Time format		AM/PM or 24 hours	24 hours
Date Format		DD/MM/YYYY YYYY/MM/DD MM/DD/YYYY YYYY/MM/DD YYYY-MM-DD Mon DD, YYYY DD-Mon-YYYY	YYYY/MM/DD

Language	Message display language	Up to 3 languages	English
Beep ON	Beeper Status	Enabled or Disabled	Disabled
Instrument ID	Instrument identification	0000 to 9999	0000
Baud Rate	Serial Communication to PC	600, 1200, 2400, 4800, 9600	9600
Meter Information	Displays general information		

PARAMETER SCREENS

Calibration Timeout

Highlight *Calibration timeout*.

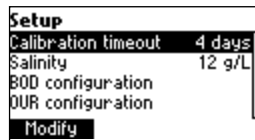

Press **Modify**.

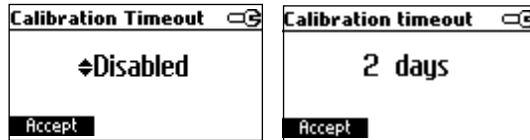

Use the ▲/▼ keys to set the desired value.

Press **Accept** to confirm or **ESC** to return without saving.

Note: If enabled "CAL DUE" warning will be displayed after Calibration timeout period has elapsed since the previous calibration.

Salinity

Highlight *Salinity*.

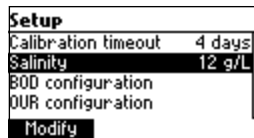

Press **Modify**.

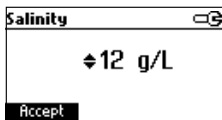

Use ▲/▼ keys to change the salinity value. Press **Accept** to confirm or **ESC** to exit without saving.

BOD Configuration

Highlight *BOD configuration*.

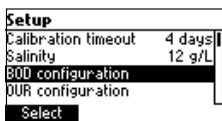

Press **Select**

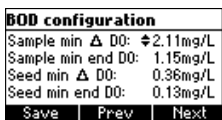

Parameters:

- **Sample min Δ DO** the minimum acceptable difference between the initial and final DO values for a sample. If the difference is less than this value the meter will show a warning message when evaluating the BOD.
Range: 0.00 to 50.00 mg/L.
- **Sample min end DO** - the minimum acceptable final DO value for a sample. If the final DO value is less than this value the meter will show a warning message when evaluating the BOD.
Range: 0.00 to 50.00 mg/L.
- **Seed min Δ DO** - the minimum acceptable difference between the initial and final DO values for a seed sample. If the difference is less than this value the meter will show a warning message when evaluating the BOD.
Range: 0.00 to 50.00 mg/L.
- **Seed min end DO** - the minimum acceptable final DO value is less than this value the meter will show a warning message when evaluating the BOD.
Range: 0.00 to 50.00 mg/L.

Press **Prev/Next** to select a different parameter.

Press ▲/▼ keys to modify the selected parameter's value.

Press **Save** to save the new BOD configuration.

Press **ESC** to leave without changing.

OUR Configuration

Highlight *OUR configuration*.

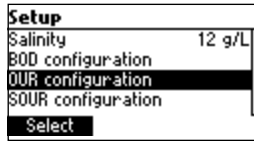

Press **Select**.

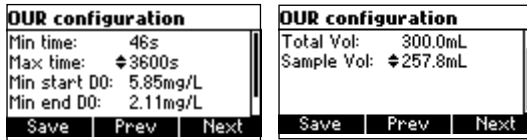

Parameters:

- **Min time** - the minimum time for the OUR test.
Range: 1 to 3600 seconds.
- **Max time** - the maximum time for the OUR test. The test will stop automatically when the maximum time has elapsed.
Range: 1 to 3600 seconds.
- **Min start DO** - the minimum accepted DO value for starting the OUR test. If the DO reading is less than this value the test cannot be started.
Range: 0.01 to 50.00 mg/L.
- **Min end DO** - the minimum accepted DO value at the end of the test. If the DO reading at the end of the OUR test is less than this value a warning message will be displayed.
Range: 0.00 to 50.00 mg/L.
- **Total volume** - the volume of the diluted mixture.
Range: 0.1 to 300.0 mL
- **Sample volume** - the volume of sample in the diluted mixture.
Range: 0.1 to 300.0 mL.

Press **Prev/Next** to select a different parameter.

Press **▲/▼** keys to modify the selected parameter's value.

Press **Save** to save the new OUR configuration.

Press **ESC** to leave without changing.

SOUR Configuration

Highlight *SOUR configuration*.

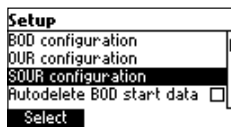

Press **Select**.

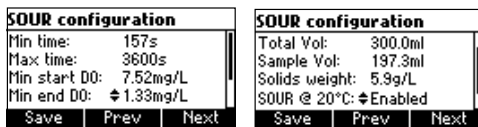

- **Min time** - the minimum time for the SOUR test.
Range: 1 to 3600 seconds.
- **Max time** - the maximum time for the SOUR test. The test will stop automatically when the maximum time has elapsed.
Range: 1 to 3600 seconds.
- **Min start DO** - the minimum accepted DO value for starting the SOUR test. If the DO reading is less than this value the test cannot be started.
Range: 0.01 to 50.00 mg/L.
- **Min end DO** - the minimum accepted DO value at the end of the test. If the DO reading at the end of the SOUR test is less than this value a warning message will be displayed.
Range: 0.00 to 50.00 mg/L.
- **Total vol** - the volume of the diluted mixture.
Range: 0.1 to 300.0 mL
- **Sample vol** - the volume of sample in the diluted mixture.
Range: 0.1 to 300.0 mL.
- **Solids weight**: Total solids or Volatile suspended solids weight.
Range: 0.1 to 300.0 g/L.
- **SOUR @ 20 °C**: If this option to enabled the SOUR value is corrected to 20 °C.

Press **Prev/Next** to select a different parameter.

Press **▲/▼** keys to modify the selected parameter's value.

Press **Save** to save the new SOUR configuration.

Press **ESC** to leave without changing.

Autodelete BOD Start Data

Highlight *Autodelete BOD start data*.

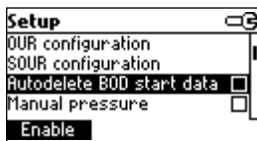

Press the displayed functional key to enable/disable the feature.

If enabled the BOD initial data record used in BOD result evaluation is deleted automatically after the BOD result has been saved into the instrument's memory (**LOG** key pressed).

If disabled, the user has to delete BOD initial data records that were used in BOD result evaluation, entering **View initial BOD data** mode.

Manual Pressure

Highlight *Manual pressure*.

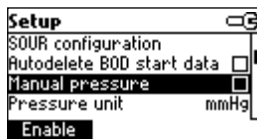

Press the displayed functional key to enable/disable the feature.

If enabled, the pressure can be entered by the user, while in measurement screen, using ▲/▼ keys.

Pressure Unit

Highlight *Pressure unit*.

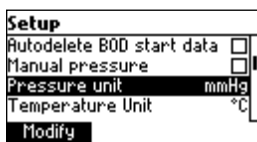

Press **Modify**.

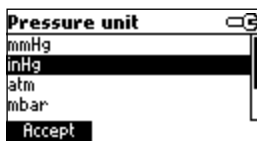

Use ▲/▼ keys to highlight the desired pressure unit.
 Press **Accept** to confirm or **ESC** to exit without saving.

Temperature Unit

Highlight *Temperature Unit*.

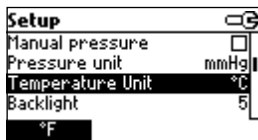

Press the displayed functional key in order to change the temperature unit.

Backlight

Highlight *Backlight*.

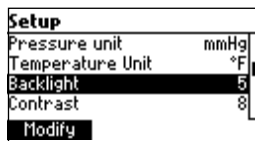

Press **Modify**.

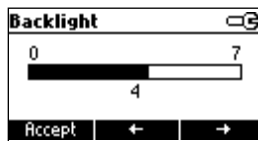

Use ← / → keys to change intensity then press **Accept** to confirm.

Press **ESC** to leave without changing.

Contrast

Highlight *Contrast*.

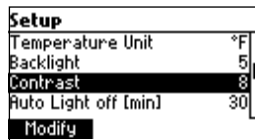

Press **Modify**.

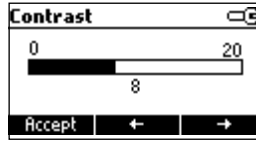

Use ← / → keys to change intensity then press **Accept** to confirm.

Press **ESC** to leave without changing.

Auto Light off

Highlight *Auto Light off*.

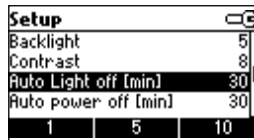

Press one of the functional keys to change the option.

Auto power off

Highlight *Auto power off*.

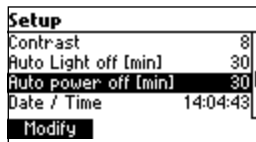

Press **Modify**.

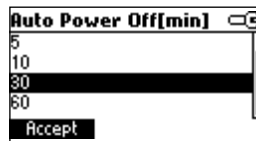

Use ▲ / ▼ keys to select interval then press **Accept**.

Press **ESC** to leave without changing.

Date/Time

Highlight *Date / Time*.

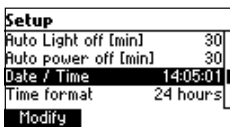

Press **Modify**.

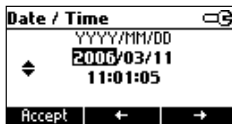

Use ← / → keys to select item. Use ▲/▼ keys to change the focused values.

Press **Accept** to confirm the new setting, or **ESC** to leave without changing.

Time Format

Highlight *Time format*.

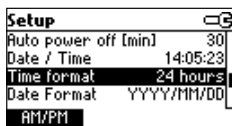

Press functional keys to change the option.

Date Format

Highlight *Date Format*.

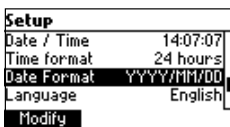

Press **Modify**.

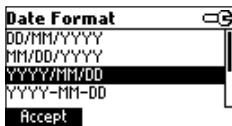

Use ▲/▼ keys to select date format then press **Accept**.

Press **ESC** to leave without changing.

Language

Highlight *Language*.



Use the desired functional key to change the option. Wait until the new language is loaded.

If any language can be loaded, the instrument will work in safe mode. In this mode all messages are displayed in English and **Help** is not available.

Beep On

Highlight *Beep On*.

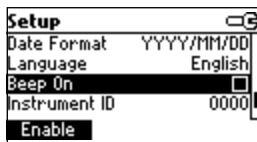

Press the displayed functional key to enable/disable beep.

When enabled, the beep sounds as a short beep every time a key is pressed or when the calibration can be confirmed.

A long beep alerts that the pressed key is not active or a wrong condition is detected while in calibration.

Instrument ID

Highlight *Instrument ID*.

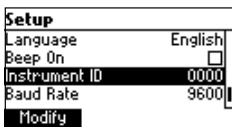

Press **Modify**.

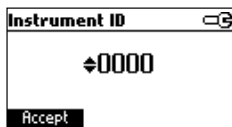

Use **▲/▼** keys to change the instrument's ID. Press **Accept** to confirm or **ESC** to exit without saving.

Baud Rate

Highlight *Baud Rate*.

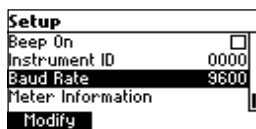

Press **Modify**.

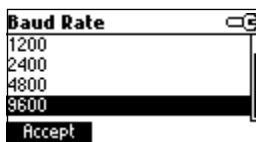

Use ▲/▼ keys to select the desired communication baud. Press **Accept** to confirm or **ESC** to exit.

Meter Information

Highlight *Meter Information*.

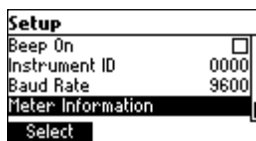

Press **Select**.

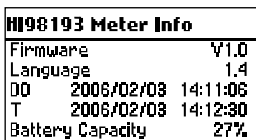

The meter information is displayed:

- Firmware version
- Language version
- DO and Temperature factory calibration date/time
- Battery Capacity

This feature allows the user to log DO, BOD, OUR and SOUR measurements. All logged data can be transferred to a PC through the **USB** port using **HI92000** application.

The maximum logging space is 400 records.

LOGGING THE CURRENT DATA

To store the current reading into memory, press **LOG**.



The instrument will display for a few seconds the record number and the amount of the free log space (in %).

If the LOG space is full, the “**Log space is full**” message will be displayed for a few seconds when **Log** key is invoked.

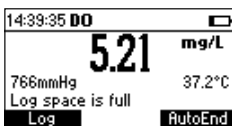

Enter **View Logged Data** mode and delete records in order to free log space.

VIEW LOGGED DATA

Press **RCL** to retrieve the stored information while in measurement mode for the specific range (DO, BOD, OUR, SOUR).

The list of records is displayed.

DO recall:

ID	DO	Unit	Date
1	99.7	%sat	2006/02/03
2	99.8	%sat	2006/02/03
3	5.21	mg/L	2006/02/03
4	81.7	%sat	2006/02/03

Buttons: Delete All, Delete, More

BOD recall:

ID	BOD(mg/L)	Date
0022	7.54	2006/02/24
1202	7.54	2006/02/24
0103*	12.10	2006/02/28
0543*	12.10	2006/02/28

Buttons: Delete All, Delete, More

OUR recall:

	OUR[mg/L/h]	Date
1	305.14	2006/02/03
2	185.14	2006/02/03
3	131.84	2006/02/03
4	341.63	2006/02/03

Delete All Delete More

SOUR recall:

	SOUR[mg/h/g]	Date
1	18.62	2006/02/03
2	12.75	2006/02/03
3	12.86	2006/02/03
4	11.42	2006/02/03

Delete All Delete More

If there is no logged data, the instrument will display "No Records".

Use ▲/▼ keys to scroll the list of records.

Press **Delete All** to enter *Delete All* screen.

Press **Delete** to enter *Delete* records screen.

Press **More** to view more information of the focused record.

If **More** is pressed, a complete set of information is displayed.

Press **Pg Up** or **Pg Down** to toggle between information screens.

DO recall:

Record number: 1
Date: 2006/02/03
Time: 14:35:26
DO: 99.7%sat
Temperature: 24.5°C

Pg Down

Record number: 1
Pressure: 765mmHg
Salinity: 12g/L

Pg Up

BOD recall:

ID: 0945, Sample, S.C.
BOD: 8.60mg/L
Bottle Vol: 300.0mL
Sample Vol: 186.7mL
Seed Vol: 50.0mL

Pg Down

ID: 0945, Sample, S.C.
Initial Parameters:
2006/03/11 11:09:52
DO: 12.87mg/L T: 20.8°C
P: 764mmHg Salt: 7g/L

Pg Up Pg Down

ID: 0945, Sample, S.C.
Final Parameters:
2006/03/16 11:13:54
DO: 6.96mg/L T: 20.8°C
P: 764mmHg Salt: 7g/L

Pg Up Pg Down

ID: 0945, Sample, S.C.
Seed bottle ID: 0950

Pg Up

*Note: "S.C." message in the title bar means seed corrected.
 "not S.C." message in the title bar means seed not corrected.*

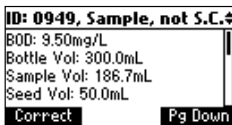

The **Correct** functional key will be displayed if the BOD result was not seed corrected.

Note: For a seed corrected sample, the last page will show the Seed bottle ID used for correction.

OUR recall:

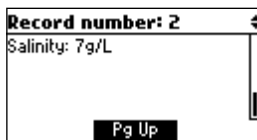
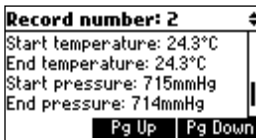
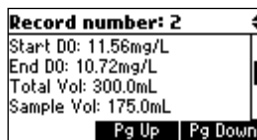
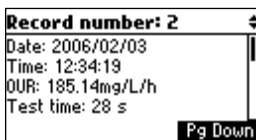

SOUR recall:

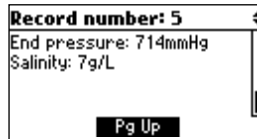
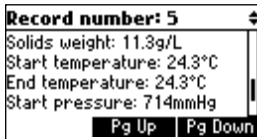
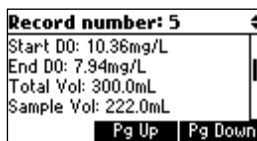
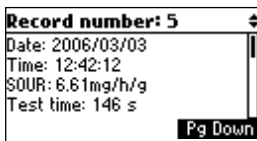

Note: In case that the SOUR value was corrected to 20 °C the message "(@20 °C)" will be displayed before the SOUR value.

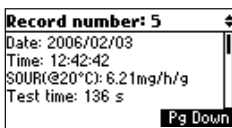

Use ▲/▼ keys to view the complete log information about the next/previous record while ⬅ are displayed.

If **Delete** is pressed.

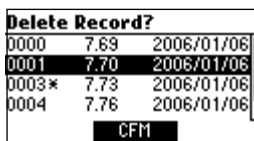

Use ▲/▼ key to highlight the record to be deleted and then press **CFM**.

Press **ESC** to exit.

If **Delete All** is pressed the instrument asks for confirmation. Press **CFM** to confirm or **ESC** to exit without deleting.

To freeze the first stable reading on the LCD press **AutoEnd** while the instrument is in DO measurement mode.

The **“Wait”** symbol will blink until the reading is stable.



When the reading is stable **“Hold”** icon will be displayed.

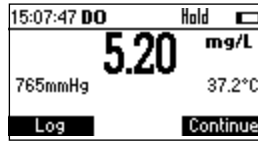

Press **Continue** at any moment in order to enter continuous reading mode.

The **HI98193** meter has an internal barometer for automatic pressure compensation for DO readings. The instrument is factory calibrated for pressure measurements and no user calibration is needed. If the pressure reading is inaccurate, a pressure calibration should be performed.

For an accurate calibration follow the instructions below.

In order to perform a pressure calibration a reference barometer with at least 1 mmHg resolution is necessary.

Press **CAL** from any measure mode (DO, BOD, OUR or SOUR). The calibration menu will be displayed.



Press **Pressure** functional key to select the pressure calibration. The pressure calibration screen will be displayed.

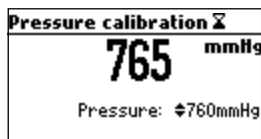

Using the **▲/▼** keys, enter the true local barometric pressure read from the reference barometer. Do **NOT** use the pressure reported by the weather bureau. Weather bureaus correct pressures to sea level. When the reading is stable within range of the entered barometric pressure the **CFM** functional key is displayed.

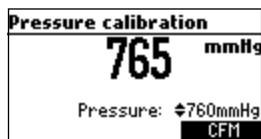

Press **CFM** to confirm the calibration.

The instrument will return to the main screen and will memorize the calibration data.

Note: If a pressure calibration has been previously performed it is possible to erase the calibration by pressing the Clear functional key.

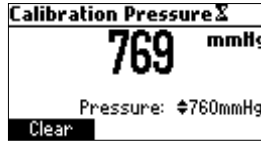

The "Calibration cleared" message will be displayed for a few seconds and the meter will return to the main screen.

If the measured pressure is too far from the calibration point the "Wrong pressure" error message will be shown on the display and the calibration can't be confirmed.

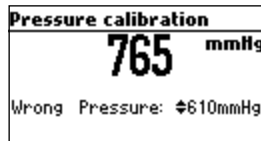

Verify if the value read from the reference barometer was entered correctly.
Contact your local Hanna Instruments Office if calibration cannot be performed.

All the instruments are factory calibrated for temperature.

Hanna Instruments's DO probes are interchangeable and no temperature calibration is needed when they are replaced.

If the temperature measurements are inaccurate, temperature recalibration should be performed.

For an accurate recalibration follow instructions below.

The temperature calibration can be performed in one or two points.

It is better to perform a two points calibration.

The calibration can be performed in any 2 points that have at least 25 °C distance between. It is recommended that the first point be near 0 °C and the second point near 50 °C.

Press **CAL** from any measure mode (DO, BOD, OUR or SOUR).

The calibration menu will be displayed.

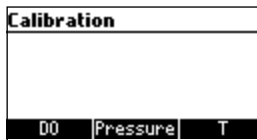

Press the **T** functional key to select the temperature calibration.

- Prepare a vessel containing ice and water and another one containing hot water (at approximately 50 °C or 122 °F). Place insulation material around the vessels to minimize temperature changes. Use a calibrated thermometer with a resolution of 0.1 °C as a reference thermometer.
- Ensure the DO probe is connected to the meter.
- Immerse the DO probe into the vessel with ice and water as close as possible to the reference thermometer.
- Allow a few seconds for the probe to stabilize.

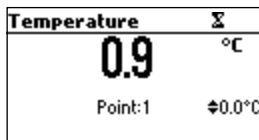

- Use the **▲**/**▼** keys to set the calibration point values to that of the ice and water mixture, measured by the reference thermometer.

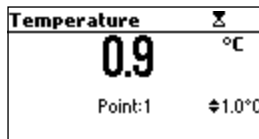

- When the reading is stable and within range of the selected calibration point, the CFM functional key is displayed.

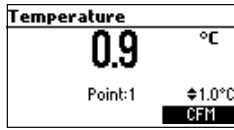

- Press CFM to confirm.
- The second expected calibration point is displayed.

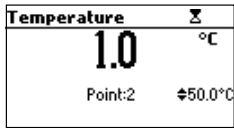

- Immerse the DO probe into the second vessel as close as possible to the reference thermometer.
- Allow a few seconds for the probe to stabilize.

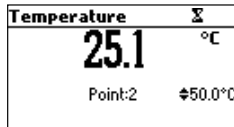

- Use the ▲/▼ key to set the calibration point value to that measured by the reference thermometer.

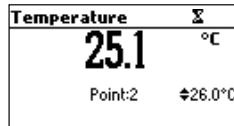

- When the reading is stable and within range of the selected calibration point, the CFM functional key is displayed.

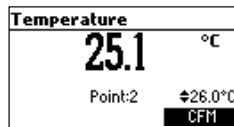

- Press CFM to confirm. The instrument will return to the main screen.

Note: If the reading is not within range of the selected calibration point or the difference between first selected point and second selected point is less than 25 °C, "Wrong" message will blink.

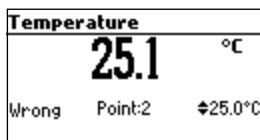

If the cause of "Wrong" message is the difference between calibration points increase the temperature of the vessel with hot water until the calibration points are more than 25 °C apart.

If the cause of "Wrong" message is the temperature reading value change the probe and restart calibration.

If calibration cannot be performed contact your local Hanna Instruments Office.

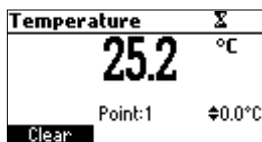

If a temperature calibration has been previously performed it is possible to erase the calibration by pressing the Clear functional key.

The "Calibration cleared" message will be displayed for a few seconds and the meter will return to the main screen.

For one point calibration press ESC after first point was confirmed.

The instrument will return to the main screen and will memorize the calibration data.

Data transmission from the instrument to the PC can be done with the **HI92000** Windows® compatible software (optional). **HI92000** also offers graphing and on-line help feature.

Data can be exported to the most popular spreadsheet programs for further analysis.

To allow our users access to the latest version of Hanna Instruments PC compatible software, we made the products available for download at <http://software.hannainst.com>. Select the product code and click **Download Now**. After download is complete, use the **setup.exe** file to install the software.

To connect your instrument to a PC, use a **USB** cable connector. Make sure that your instrument is switched off and plug one connector to the instrument **USB** socket and the other to the serial or USB port of your PC.

Note: If you are not using Hanna Instruments HI92000 software, please see the following instructions.

SENDING COMMANDS FROM PC

It is also possible to remotely control the instrument with any terminal program. Use a **USB** cable to connect the instrument to a PC, start the terminal program and set the communication options as follows: 8, N, 1, no flow control.

COMMAND TYPES

To send a command to the instrument follow the next scheme:

<command prefix> <command> <CR>

where: <command prefix> is a selectable 16 ASCII character.

<command> is the command code.

Note: Either small or capital letters can be used.

SIMPLE COMMANDS

KF1	Is equivalent to pressing functional key 1
KF2	Is equivalent to pressing functional key 2
KF3	Is equivalent to pressing functional key 3
RNG	Is equivalent to pressing RANGE
MOD	Is equivalent to pressing MODE
CAL	Is equivalent to pressing CAL
UPC	Is equivalent to pressing the UP arrow key
DWC	Is equivalent to pressing the DOWN arrow key
RCL	Is equivalent to pressing RCL
SET	Is equivalent to pressing SETUP
GLP	Is equivalent to pressing GLP
OFF	Is equivalent to pressing OFF

CHR xx Change the instrument range according to the parameter value (xx):

- xx=20 DO range
- xx=21 BOD range
- xx=22 OUR range
- xx=23 SOUR range

The instrument will answer for these commands with:

<STX> <answer> <ETX>

where: <STX> is 02 ASCII code character (start of text)

<ETX> is 03 ASCII code character (end of text)

<answer>:

<ACK> is 06 ASCII code character (recognized command)

<NAK> is 21 ASCII code character (unrecognized command)

<CAN> is 24 ASCII code character (corrupted command)

COMMANDS REQUIRING AN ANSWER

The instrument will answer for these commands with:

<STX> <answer> <checksum> <ETX>

where the checksum is the bytes sum of the answer string sent as 2 ASCII characters.

All the answer messages are with ASCII characters.

RAS Causes the instrument to send a complete set of readings in according with the current range:

- DO, temperature, and pressure on the DO and BOD range
- DO, temperature, pressure, OUR/SOUR value, OUR/SOUR test time on the OUR/SOUR range
- BOD result, start DO value and end DO value when in the BO result screen (meter mode 25)

The answer string contains:

- Meter mode (2 chars):
 - 20 - DO range
 - 21 - BOD range
 - 22 - OUR range
 - 23 - SOUR range
 - 25 - BOD result screen
- Meter status (2 chars of status byte): represents a 8 bit hexadecimal encoding
 - **0x10**: temperature probe connection
 - **0x20**: DO measure unit (0 = %, 1 = mg/L)
 - **0x01**: new GLP data available
 - **0x02**: new setup parameter

- **0x04**: out of calibration range
- **0x08**: the meter is in autoend mode
- Reading status: R - in range, O - over range, U - under range
 - The following status flags are sent for all modes except mode 25
 - DO reading range flag
 - temperature reading range flag
 - pressure reading range flag
 - OUR/SOUR reading range flag (sent only if in OUR/SOUR measure mode)
 - The following status flag is sent only for mode 25
 - BOD reading range flag
- Readings
 - The following values are sent for all modes except mode 25
 - DO reading, including sign and decimal point (8 chars)
 - temperature, including sign and decimal point (8 chars)
 - pressure value, including sign and decimal point, always in mmHg (11 chars)
 - OUR/SOUR reading, including sign and decimal point (sent only if in OUR/SOUR measure mode) (8 chars)
 - OUR/SOUR counter (sent only if in OUR/SOUR measure mode) (4 chars)
 - The following values are sent only for mode 25
 - BOD reading, including sign and decimal point (8 chars)
 - initial DO value, including sign and decimal point [mg/L] (6 chars)
 - final DO value, including sign and decimal point [mg/L] (6 chars)

MDR Requests the instrument model name and firmware code (16 ASCII chars).

GLP Requests the calibration data record.

The answer string contains:

- the number of calibrated buffers (1 char)
- calibrated buffer unit (0 = %, 1 = mg/L) (1 char)
- buffer value including sign and decimal point (6 chars)
- calibrated buffer unit (0 = %, 1 = mg/L) (this value is sent only if there is a two point calibration) (1 char)
- buffer value including sign and decimal point (this value is sent only if there is a two point calibration) (6 chars)
- salinity value (3 chars)
- pressure value in mmHg, including sign and decimal point (11 chars)
- temperature value including sign and decimal point (8 chars)
- calibration time: yymmddhhmmss (12 chars).

PAR Requests the setup parameters setting.

The answer string contains:

- backlight value (1 char)
- contrast value (2 chars)
- instrument ID (4 chars)
- calibration alarm timeout (2 chars)
- Setup information (2 chars): 8 bit hexadecimal encoding:
 - **0x01**: - beep is on
 - **0x04**: - Celsius / Fahrenheit display (°C if the bit is set)
 - **0x10**: - manual pressure (1 if activated, 0 otherwise)
- Auto Light Off time (3 chars)
- Auto Power Off time (3 chars)
- Salinity value (3 chars)
- Pressure unit (1 char): 0 - mmHg, 1 - inHg, 2 - atm, 3 - mbar, 4 - psi, 5 - kPa
- **BOD** configuration values
 - sample minimum delta DO, including sign and decimal point (6 chars)
 - sample minimum end DO, including sign and decimal point (6 chars)
 - seed minimum delta DO, including sign and decimal point (6 chars)
 - seed minimum end DO, including sign and decimal point (6 chars)
- **OUR** configuration values
 - minimum time in seconds (4 chars)
 - maximum time in seconds (4 chars)
 - minimum start DO including sign and decimal point (6 chars)
 - minimum end DO including sign and decimal point (6 chars)
 - total volume including sign and decimal point (6 chars)
 - sample volume including sign and decimal point (6 chars)
- **SOUR** configuration values
 - minimum time in seconds (4 chars)
 - maximum time in seconds (4 chars)
 - minimum start DO including sign and decimal point (6 chars)
 - minimum end DO including sign and decimal point (6 chars)
 - total volume including sign and decimal point (6 chars)
 - sample volume including sign and decimal point (6 chars)
 - solids weight including sign and decimal point (6 chars)
 - SOUR temperature correction (1 = enabled, 0 = disabled) (1 char)
- The short name of the selected language (3 chars)

NSLx Requests the number of logged samples (4 chars)

The command parameter (x - 1 char)

- **D** - the request is for DO
- **B** - the request is for BOD
- **O** - the request is for OUR
- **S** - the request is for SOUR
- **I** - the request is for BOD initial values

LODDxxx Requests the xxxth DO logged data

LODBxxx Requests the xxxth BOD logged data

LODOxxx Requests the xxxth OUR logged data

LODSxxx Requests the xxxth SOUR logged data

LODIxxx Requests the xxxth initial BOD value logged data

LODDALL Requests all the DO log on demand

LODBALL Requests all the BOD log on demand

LODOALL Requests all the OUR log on demand

LODSALL Requests all the SOUR log on demand

LODIALL Requests all the initial BOD values log

The answer string for each record contains:

- The logged mode (2 chars)
 - 20 - DO range
 - 21 - BOD range
 - 22 - OUR range
 - 23 - SOUR range
 - 24 - BOD initial values
- **DO log data:**
 - Measurement unit (0 = %, 1 = mg/L) (1 char)
 - DO value including sign and decimal point (8 chars)
 - Salinity value [g/L] (3 chars)
 - Pressure value in mmHg, including sign and decimal point (11 chars)
 - Temperature value including sign and decimal point (8 chars)
- **BOD log data:**
 - Sample type (1 = sample, 0 = seed) (1 char)
 - Seed corrected (1 = corrected, 0 = not corrected) (1 char)
 - Bottle ID (4 chars)
 - BOD value including sign and decimal point [mg/L] (8 chars)
 - Bottle volume including sign and decimal point [ml] (6 chars)

- Sample volume including sign and decimal point [ml] (6 chars)
- Seed volume including sign and decimal point [ml] (6 chars)
- Start salinity value [g/L] (3 chars)
- End salinity value [g/L] (3 chars)
- Start pressure value in mmHg, including sign and decimal point (11 chars)
- End pressure value in mmHg, including sign and decimal point (11 chars)
- Start temperature value, including sign and decimal point (8 chars)
- End temperature value, including sign and decimal point (8 chars)
- Start DO value including sign and decimal point [mg/L] (8 chars)
- End DO value including sign and decimal point [mg/L] (8 chars)
- Seed ID (for seed corrected samples) (4 chars)
- **OUR log data:**
 - Start DO value including sign and decimal point [mg/L] (8 chars)
 - End DO value including sign and decimal point [mg/L] (8 chars)
 - Salinity value [g/L] (3 chars)
 - Start pressure value in mmHg, including sign and decimal point (11 chars)
 - End pressure value in mmHg, including sign and decimal point (11 chars)
 - Start temperature value, including sign and decimal point (8 chars)
 - End temperature value, including sign and decimal point (8 chars)
 - Total volume, including sign and decimal point [ml] (6 chars)
 - Sample volume, including sign and decimal point [ml] (6 chars)
 - Delta time [s] (4 chars)
 - OUR value, including sign and decimal point [mg/L/h] (8 chars)
- **SOUR log data:**
 - Start DO value including sign and decimal point [mg/L] (8 chars)
 - End DO value including sign and decimal point [mg/L] (8 chars)
 - Salinity value [g/L] (3 chars)
 - Start pressure value in mmHg, including sign and decimal point (11 chars)
 - End pressure value in mmHg, including sign and decimal point (11 chars)
 - Start temperature value, including sign and decimal point (8 chars)
 - End temperature value, including sign and decimal point (8 chars)
 - Total volume, including sign and decimal point [ml] (6 chars)
 - Sample volume, including sign and decimal point [ml] (6 chars)
 - Delta time [s] (4 chars)
 - SOUR value, including sign and decimal point [mg/h/g] (8 chars)
 - Solids weight, including sign and decimal point [g/L] (6 chars)

- SOUR temperature correction (1 = SOUR@20°C, 0 = SOUR not corrected) (1 char)
- **BOD DATA log data:**
 - Sample type (1 = sample, 0 = seed) (1 char)
 - Bottle ID (4 chars)
 - DO value, including sign and decimal point [mg/L] (8 chars)
 - Bottle volume, including sign and decimal point [ml] (6 chars)
 - Sample volume, including sign and decimal point [ml] (6 chars)
 - Seed volume, including sign and decimal point [ml] (6 chars)
 - Salinity value [g/L] (3 chars)
 - Pressure value in mmHg, including sign and decimal point (11 chars)
 - Temperature value, including sign and decimal point (8 chars)
 - Log time: yy mm dd hh mm ss (12 chars)

Notes: "Err8" is sent if the instrument is not in measurement mode.

"Err6" is sent if the requested range is not available.

"Err4" is sent if the requested set parameter is not available.

"Err3" is sent if the Log on demand is empty.

"Err9" is sent if the battery power is less than 30%.

Invalid commands will be ignored.

To replace the batteries, follow the next steps:

- Turn OFF the instrument.
- Open the battery compartment by removing the four screws from the back of the instrument.
- Remove the old batteries.
- Insert four new 1.5V AA batteries in the battery compartment while paying attention to the correct polarity.
- Close the battery compartment using the four screws.

If the battery capacity is less than 20 % the serial communication and the backlight feature are not available.

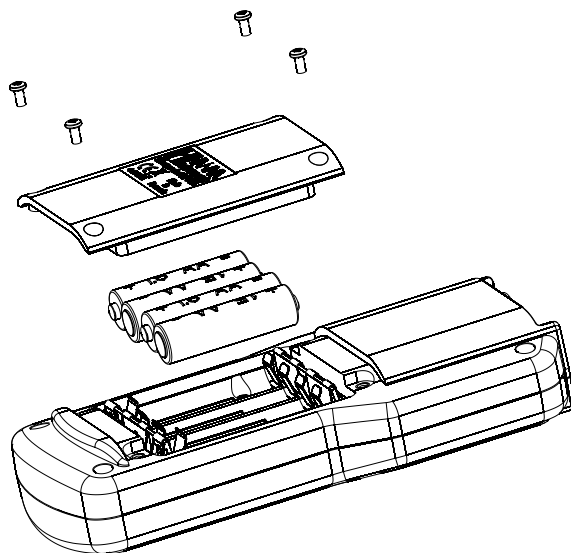

Note: The instrument is provided with the BEPS (Battery Error Prevention System) feature, which automatically turns the instrument off when the batteries level is too low to ensure reliable readings.

The oxygen probe is made of reinforced plastic for maximum durability. A thermistor temperature sensor provides temperature measurements of the sample. Use the protective cap when not in use.

To replace the membrane or refill with electrolyte, proceed as follows:

Remove the protective cap by gently twisting, and pulling it off the body of the probe (see fig. 1).

Unscrew the membrane cap by turning it counterclockwise (see fig. 2).

Wet the sensor by soaking the bottom 2½ cm (1") of the probe in electrolyte for five minutes.

Rinse the new membrane cap, supplied with the meter with electrolyte solution while shaking it gently. Refill with clean electrolyte solution.

Gently tap the sides of the membrane cap with your finger tip to ensure that no air bubbles remain trapped. Do not tap directly the bottom with your finger, as this will damage the membrane.

Make sure that the rubber O-Ring sits properly inside the membrane cap. With the sensor facing down, slowly screw the membrane cap clockwise. Some electrolyte will overflow.

The Platinum cathode (#8 in the Probe Functional Description page 9) should always be bright and untarnished. If it is tarnished or stained, the cathode should be cleaned. You can use a clean lint-free paper towel or cloth. Rub the cathode very gently side to side 4-5 times. This will be enough to polish and remove any stains without damaging the platinum tip. Afterwards, rinse the probe with deionized or distilled water and install a new membrane cap using fresh electrolyte and follow the steps above. Recalibrate the instrument.

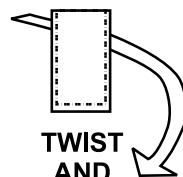

TWIST AND PULL

fig. 1

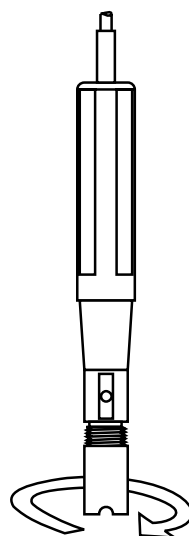

UNSCREW

fig. 2

Important

In order to have accurate and stable measurements, it is important that the membrane surface is in perfect condition. This semipermeable membrane isolates the sensor elements from the environment but allows oxygen to enter. If any dirt is observed on the membrane, rinse carefully with distilled or deionized water. If any imperfections still exist, or any damage is evident (such as wrinkles or tears-holes), the membrane should be replaced.

Make sure that the O-Ring sits properly in the membrane cap.

SYMPTOMS	PROBLEM	SOLUTION
Reading fluctuates up and down (noise).	DO probe not properly connected.	Connect the probe.
Display shows DO reading blinking.	Reading out of range.	Recalibrate the meter; Check the sample is within measurable range.
Meter fails to calibrate or gives faulty readings.	Broken DO probe.	Replace the probe.
At startup the meter displays Hanna Instruments logo permanently.	One of the keys is blocked.	Check the keyboard or contact your local Hanna Instruments Office.
"Err xx" message displayed at startup.	Internal error.	Contact your local Hanna Instruments Office.
Meter shuts off.	Dead batteries; Auto Power Off feature is enabled: in this case, meter shuts off after selected period of non use.	Replace batteries; Press ON/OFF .
The instrument does not start when pressing ON/OFF .	Initialization error.	Press and hold down ON/OFF for about 20 seconds or disconnect and then connect the batteries.

Code	Description
HI98501	Digital thermometer (range: -50.0 to 150.0 °C/-58.0 to 302 °F)
HI7040L	Zero Oxygen Solution
HI7041S	Refilling Electrolyte Solution (30 mL)
HI764073	Spare probe with 4 meter (13.4') cable
HI76407A/P	Spare membranes (5 pcs.)
HI92000	Windows® compatible software application
HI920015	Micro USB cable

CERTIFICATION

All Hanna Instruments conform to the **CE European Directives**.



Disposal of Electrical & Electronic Equipment. The product should not be treated as household waste. Instead hand it over to the appropriate collection point for the recycling of electrical and electronic equipment which will conserve natural resources.

Disposal of waste batteries. This product contains batteries, do not dispose of them with other household waste. Hand them over to the appropriate collection point for recycling.

Ensuring proper product and battery disposal prevents potential negative consequences for the environment and human health. For more information, contact your city, your local household waste disposal service, the place of purchase or go to www.hannainst.com.



Recommendations for users

Before using this product, make sure it is entirely suitable for your specific application and for the environment in which it is used. Any variation introduced by the user to the supplied equipment may degrade the meters' performance. For yours and the meter's safety do not use or store the meter in hazardous environments.

Warranty

The **HI98193** is warranted for two years against defects in workmanship and materials when used for their intended purpose and maintained according to instructions. Electrodes and probes are guaranteed for six months. This warranty is limited to repair or replacement free of charge.

Damage due to accidents, misuse, tampering or lack of prescribed maintenance is not covered.

If service is required, contact your local Hanna Instruments Office. If under warranty, report the model number, date of purchase, serial number and the nature of the problem. If the repair is not covered by the warranty, you will be notified of the charges incurred. If the instrument is to be returned to Hanna Instruments, first obtain a Returned Goods Authorization (RGA) number from the Technical Service department and then send it with shipping costs prepaid. When shipping any instrument, make sure it is properly packed for complete protection.

Hanna Instruments reserves the right to modify the design, construction or appearance of its products without advanced notice.

World Headquarters

Hanna Instruments Inc.
Highland Industrial Park
584 Park East Drive
Woonsocket, RI 02895 USA
www.hannainst.com



MAN98193

Printed in ROMANIA